

HEAVY-DUTY NATURAL LATEX GLOVES

- ◆ Soft, comfortable, and durable
- ◆ Made especially for dish washers, launderers, car washers, and gardeners

ITEM	DESCRIPTION	UOM	CASE
NLGH-18	10-1/2" x 18-1/2"	Pair	12/24

NATURAL LATEX GLOVES

ITEM	DESCRIPTION	COLOR	UOM	CASE
NLG-816	Small	Yellow	Pair	12/60
NLG-916	Medium	Yellow	Pair	12/60
NLG-1018	Large	Black	Pair	12/60

GLOVES

ITEM	DESCRIPTION	SIZE	UOM	CASE
GLFP-M	Vinyl Disposable, Powder-Free, 100 pcs/box	M	Box	10
GLFP-L	Vinyl Disposable, Powder-Free, 100 pcs/box	L	Box	10
GLP-M	PE Textured, 500 pcs/box	M	Box	10
GLP-L	PE Textured, 500 pcs/box	L	Box	10

WHITE SERVICE GLOVES

- ◆ 100% Cotton

ITEM	DESCRIPTION	COLOR	UOM	CASE
GLC-M	Medium (6 Pairs)	White	Doz	100
GLC-L	Large (6 Pairs)	White	Doz	100

GLOVES



NLGH-18



NLG-816



NLG-1018



GLP-M



GLC-M

WIPER BRACKET & GLOVE BOX HOLDER

ITEM	DESCRIPTION	DIMENSIONS	UOM	CASE
WHW-5	Wiper Bracket, Wall Mount	4" x 5" x 8-1/4"	Each	12/24
WHW-10	Glove Box Holder	10" x 3" x 5"	Each	12/24

WALL BRACKETS



WHW-5



WHW-10
(Gloves not included)

FIRST AID CABINET

- ◆ Stainless steel with lockable glass door

ITEM	DESCRIPTION	UOM	CASE
SFAC-12	12" x 12" x 4-3/4"	Each	4

FIRST AID CABINET



SFAC-12



= Cash & Carry / Retail Packaging

FLOOR MATS

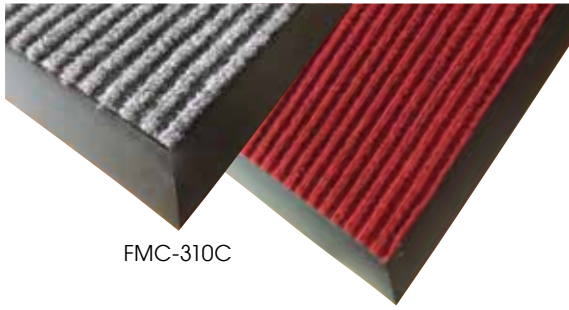

FMC-310C

FMC-310U



CARPET FLOOR MATS

- ◆ Vinyl backing prevents curling and ripping better than rubber and stays flat for safe footing

ITEM	DESCRIPTION	COLOR	UOM	CASE
FMC-310C	3' x 10'	Charcoal	Each	1
FMC-310U	3' x 10'	Burgundy	Each	1
FMC-35C	3' x 5'	Charcoal	Each	1
FMC-35U	3' x 5'	Burgundy	Each	1
FMC-46C	4' x 6'	Charcoal	Each	1
FMC-46U	4' x 6'	Burgundy	Each	1

WINCO FLOOR MATS	COMPETITOR FLOOR MATS

RUBBER FLOOR MATS

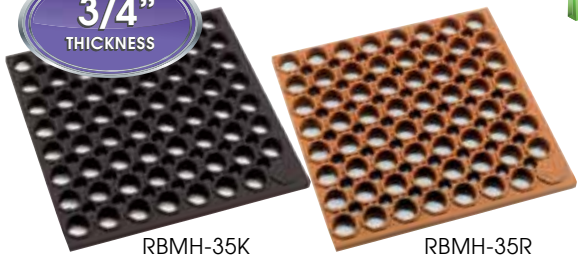

RBMH-35K

RBMH-35R

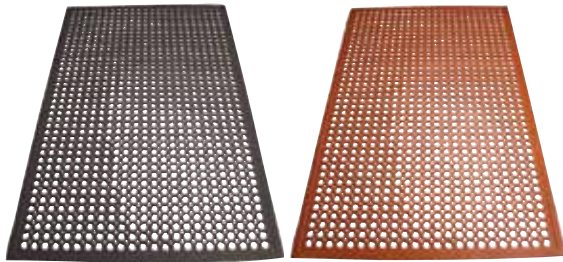

RBM-35K

RBM-35R

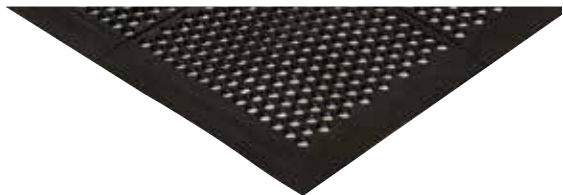

RBMM-35K



RBMI-33R

- ◆ Top-grade rubber
- ◆ Durable for long-term wear



STRAIGHT EDGE NATURAL RUBBER FLOOR MATS

- ◆ Grease resistant

ITEM	DESCRIPTION	COLOR	UOM	CASE
RBMH-35K*	3' x 5' x 3/4" Anti-Fatigue	Black	Each	1
RBMH-35R*	3' x 5' x 3/4" Grease-Proof	Red	Each	1

*Pallet rate pricing is available for this item with quantities of 50 pieces or more

BEVELED EDGE RUBBER FLOOR MATS

ITEM	DESCRIPTION	COLOR	UOM	CASE
RBM-35K*	3' x 5' x 1/2"	Black	Each	1
RBM-35R*	3' x 5' x 1/2"	Red	Each	1

*Pallet rate pricing is available for this item with quantities of 158 pieces or more

PREMIUM BEVELED EDGE RUBBER FLOOR MAT

- ◆ Natural rubber

ITEM	DESCRIPTION	COLOR	UOM	CASE
RBMM-35K	3' x 5' x 3/8"	Black	Each	1

RUBBER INTERLOCKING FLOOR MATS

ITEM	DESCRIPTION	COLOR	UOM	CASE
RBMI-33K	3' x 3' x 1/2"	Black	Each	1
RBMI-33R	3' x 3' x 1/2"	Red	Each	1

SLENDER TRASH CANS

◆ Lid sold separately

ITEM	DESCRIPTION	COLOR	UOM	CASE
PTC-23SG*	23 Gallon	Gray	Each	1
PTC-23B*	23 Gallon	Brown	Each	1
PTC-23K*	23 Gallon, Black	Black	Each	1
PTC-23L*	23 Gallon Recycle Can	Blue	Each	1
PTCL-23	Lid for PTC-23SG	Gray	Each	4
PTCL-23B	Lid for PTC-23B	Brown	Each	4
PTCL-23K	Lid for PTC-23K	Black	Each	4
PTCL-23L	Lid for PTC-23L	Blue	Each	4

*Pallet rate pricing is available for this item with quantities of 100 pieces or more

SPECIALTY LIDS

ITEM	DESCRIPTION	COLOR	UOM	CASE
PTCB-23L	Bottle/ Can Recycling Cover for PTC-23L	Blue	Each	6
PTCP-23L	Paper Recycling Cover for PTC-23L	Blue	Each	6

SLENDER TRASH CANS



HEAVY-DUTY TRASH CANS

◆ Lid sold separately

ITEM	DESCRIPTION	COLOR	UOM	CASE
PTC-32G*	32 Gallon	Gray	Each	1
PTC-44G**	44 Gallon	Gray	Each	1
FCW-10	10 Gallon, NSF	White	Each	6
FCW-20***	20 Gallon, NSF	White	Each	6
FCW-32***	32 Gallon, NSF	White	Each	6

*Pallet rate pricing is available for this item with quantities of 40 pieces or more **Pallet rate pricing is available for this item with quantities of 28 pieces or more ***Works with DLR-series dollies (see below section)

HEAVY-DUTY TRASH CAN LIDS

ITEM	DESCRIPTION	COLOR	UOM	CASE
PTCL-32	Lid for PTC-32G	Gray	Each	6
PTCL-44	Lid for PTC-44G	Gray	Each	6
FCW-10L	Lid for FCW-10, NSF	White	Each	24
FCW-20L	Lid for FCW-20, NSF	White	Each	12
FCW-32L	Lid for FCW-32, NSF	White	Each	12
FCW-10RC	Rotating Lid for FCW-10, NSF	White	Each	6
FCW-20RC	Rotating Lid for FCW-20, NSF	White	Each	6
FCW-32RC	Rotating Lid for FCW-32, NSF	White	Each	6

HEAVY-DUTY LARGE TRASH CANS



EXTRA HEAVY-DUTY DOLLY

◆ Holds up to 900 lbs

ITEM	DESCRIPTION	UOM	CASE
DLR-2	Extra-Heavy Dolly	Each	2
DLR-2-C	Caster for DLR-2	Each	1

DOLLY

◆ Holds up to 400 lbs

ITEM	DESCRIPTION	UOM	CASE
DLR-18	18" Dia x 6" H, Black	Each	2
DLR-18-W	Caster for DLR-18	Each	1

DOLLIES



= Cash & Carry / Retail Packaging

FLOOR CARE



MPB-36W

MPB-36



WCS-27T

WCS-25

CSF-4 & CSF-4H
(CSF-SET)

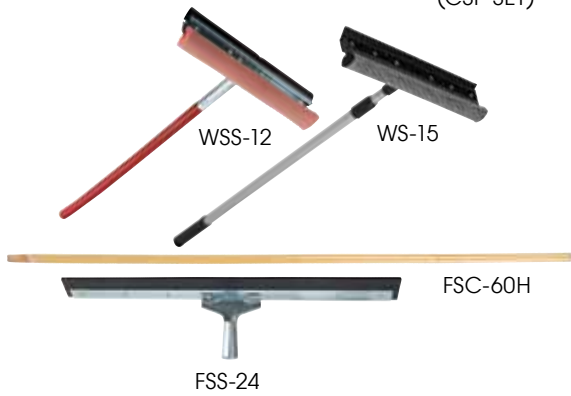

WSS-12

WS-15

FSC-60H

FSS-24



MOP-24C

MOP-32W



MOPH-7M

MOPH-7P

MOP BUCKET WITH SIDE PRESS WRINGER

ITEM	DESCRIPTION	UOM	CASE
MPB-36*	36 Qt, Yellow	Each	1
MPB-36W	Replacement Wringer for MPB-36	Each	2
MPB-36WH	Caster for MPB-36	Each	4

*Pallet rate pricing is available for this item with quantities of 30 pieces or more

FLOOR SIGNS

ITEM	DESCRIPTION	UOM	CASE
WCS-27T	27"H, Caution Cone	Each	5
WCS-25	25" x 12", English/Spanish Floor Sign	Each	12
CSF-4	Pop-up Caution Cone	Each	12/48
CSF-4H	Wall-Mount Holder for CSF-4	Each	48
CSF-SET	Set of CSF-4 and CSF-4H	Set	1

SQUEEGEES

ITEM	DESCRIPTION	UOM	CASE
WSS-12	12" with 23" Handle	Each	6/24
WS-15	15" Window Squeegee with Telescopic Handle Aluminum handle extends from 30" to 55"	Each	20
FSS-24	24", Straight Squeegee, Handle sold separately	Each	6
FSC-60H	56" Wooden Handle for FSS-24	Each	6

PREMIUM YARN MOP HEADS

- ◆ Poly cotton blend
- ◆ 4-ply yarn
- ◆ 1-1/4" narrow band

ITEM	DESCRIPTION	SIZE	UOM	CASE
MOP-24	Blue Loop End	24oz, 600g	Each	20
MOP-32	Blue Loop End	32oz, 800g	Each	20
MOP-24C	Blue Cut End	24oz, 600g	Each	20
MOP-32C	Blue Cut End	32oz, 800g	Each	20
MOP-24W	White Loop End	24oz, 600g	Each	20
MOP-32W	White Loop End	32oz, 800g	Each	20
MOP-24WC	White Cut End	24oz, 600g	Each	20
MOP-32WC	White Cut End	32oz, 800g	Each	20

MOP HANDLES

ITEM	DESCRIPTION	SIZE	UOM	CASE
MOPH-7M	Metal, Quick-Change	57"	Each	6
MOPH-7P	Plastic, Side-Release	57"	Each	6

FLOOR SCRUB BRUSH

ITEM	DESCRIPTION	UOM	CASE
BRF-10R	10" Wide	Each	12

HANDLES

ITEM	DESCRIPTION	UOM	CASE
BR-36W	36" Wooden Handle for BR-10	Each	48
BR-60W	55" Wooden Handle for BR-10	Each	6/24
FSC-60H	56" Wooden Handle for FSS-24	Each	6

CORN BROOMS

ITEM	DESCRIPTION	UOM	CASE
BRM-34	34" Wooden Handle, Toy Broom, 8.5" Width	Each	12
BRM-55	55" Metal Handle, 12" Width	Each	12/24

LOBBY BROOM AND PAN

- ◆ Built-in cover for mess-free transport

ITEM	DESCRIPTION	UOM	CASE
BRM-60L	60" Lobby Broom	Each	12
DP-13C	13" Lobby Pan	Set	10

DUST MOP

- ◆ 60" aluminum handle
- ◆ Handle, mop head, and frame all included

ITEM	DESCRIPTION	UOM	CASE
DM-24	24" Dust Mop	Each	12
DM-24H	Replacement Head for DM-24, Frame not Included	Each	24



MULTI-SURFACE SWEEPER

- ◆ Non-electric rotary sweeper with natural bristles and steel handle

ITEM	DESCRIPTION	UOM	CASE
FSW-11	11"L x 7-3/4"W x 43"H	Each	4



MOP & BROOM RACKS

Winco's mop, broom, and tool organizers are the perfect organizational tool to clean up kitchen clutter. Racks hold all types of kitchen tools and janitorial supplies. Maximize space by mounting organizers where items will be within easy reach.

- ◆ MHH-36 & MHH-24 constructed of aluminum with non-slip rubber fingers to hold tools securely in place
- ◆ MHH-5 constructed of durable ABS plastic with 6 hooks and 5 tool holders

ITEM	DESCRIPTION	UOM	CASE
MHH-5	16" Plastic Broom & Brush Organizer	Each	12
MHH-24	24" Mop Rack, Rubber Bristles	Each	6/24
MHH-36	36" Mop Rack, Rubber Bristles	Each	6/12

FLOOR CARE



= Cash & Carry / Retail Packaging

CLEANING ACCESSORIES



PPL-6G

PPL-6R



PPL-20D



BTGP-21



BTH-2028G



BTM-16AC



BTM-16W



Package comes with hanging hook



BTW-30



SPG-50



PSR-9



SP-96N

CLEANING BUCKETS

- ◆ Green pail for soap solution
- ◆ Red pail for sanitizing solution
- ◆ Not for use with food products

ITEM	DESCRIPTION	UOM	CASE
PPL-3G	3 Qt, Green	Each	12
PPL-3R	3 Qt, Red	Each	12
PPL-6G	6 Qt, Green	Each	12
PPL-6R	6 Qt, Red	Each	12

PLASTIC DOUBLE PAIL

- ◆ Wide pour spout with separate compartments for wash water and rinse water

ITEM	DESCRIPTION	DIMENSIONS	UOM	CASE
PPL-20D	19.55 Qt, Gray	17-1/2" x 13-1/2" x 11"	Each	6

GLASS POLISHING TOWEL

- ◆ 100% Cotton
- ◆ Lint-free and non-abrasive to eliminate streaking, yet is gentle for glassware
- ◆ Thousands of microscopic fibers pick up dirt and dust
- ◆ Absorbs seven times its weight in liquids; also ideal for countertops and tabletops

ITEM	DESCRIPTION	UOM	CASE
BTGP-21	16" x 29", Red Pinstripes	Doz	10/20

HERRINGBONE BAR TOWEL

- ◆ 100% cotton
- ◆ Super absorbent; ideal for wiping down tables or countertops
- ◆ Green stripe provides easy designation of towel for specific use to prevent cross-contamination

ITEM	DESCRIPTION	UOM	CASE
BTH-2028G	20" x 28", Green Stripe	Doz	10/20

MICROFIBER BAR & KITCHEN TOWELS

- ◆ Lightweight, super absorbent, and quick drying
- ◆ BTM-16AC includes white, green, yellow, brown, orange, and red
- ◆ 6 pieces per pack

ITEM	DESCRIPTION	UOM	CASE
BTM-16AC	16" x 16", Assorted Colors	Pack	20
BTM-16W	16" x 16", White	Pack	20

COTTON BAR TOWEL

- ◆ 100% white cotton

ITEM	DESCRIPTION	UOM	CASE
BTW-30	16" x 19"	Doz	10/20

STAINLESS STEEL SPONGES

ITEM	DESCRIPTION	UOM	CASE
SPG-50	Small, 50g	Each	12/144
SPG-105	Large, 105g	Each	12/72

SCOURING PADS

ITEM	DESCRIPTION	UOM	CASE
SP-96N	6" x 9-3/8", Nylon, 6 pcs/pk	Pack	60

PLASTIC SPRAY BOTTLE

ITEM	DESCRIPTION	UOM	CASE
PSR-9	28 Oz, 900 ML	Each	50

CUTTING BOARD BRUSHES

ITEM	DESCRIPTION	UOM	CASE
CBR-WT	White	Each	24/96
CBR-BN	Brown	Each	24/96
CBR-BU	Blue	Each	24/96
CBR-GR	Green	Each	24/96
CBR-RD	Red	Each	24/96
CBR-YL	Yellow	Each	24/96

BRUSHES



CBR-SERIES

BEER MUG WASHER

Eliminate hand scrubbing of glasses with Winco's Beer Mug Washer. The long-lasting nylon bristles are tough enough to get out grime, yet soft enough that they will not scratch or damage glasses. Four suction feet hold to surfaces, preventing movement while in use.

- ◆ Features one glass washer in the center with additional scrubbing bristles on the sides
- ◆ Wide enough to accommodate beer mugs, including handle
- ◆ Dirty water can be drained through detachable hose
- ◆ Durable plastic construction at space-saving size



GWB-1

ITEM	DESCRIPTION	UOM	CASE
GWB-1	Beer Mug Washer	Each	6

GLASS WASHER BRUSHES

- ◆ Four suction feet provides stability on slippery surfaces
- ◆ Dishwasher safe

ITEM	DESCRIPTION	UOM	CASE
GWB-3	3 Brushes with Base	Each	12
GWB-3-BR	Brush for GWB-3	Each	100



GWB-3

GWB-3-BR

COFFEE DECANTER BRUSH

ITEM	DESCRIPTION	UOM	CASE
CDB-11	11"L x 1-1/4"W x 1-1/4"H	Each	12/96



CDB-11

EQUIPMENT BRUSHES

ITEM	DESCRIPTION	SIZE	UOM	CASE
BR-24	L-Shaped Fryer Brush	24-1/2"	Each	12/96
BR-25	Urn Brush	25"	Each	12/96
BR-28	Kettle Valve Brush	28-1/4"	Each	12/96



BR-24

BR-25

BR-28

POT SCRUBBING BRUSHES

- ◆ Plastic handle with nylon bristles

ITEM	DESCRIPTION	UOM	CASE
BRN-8P	8"	Each	12/72
BRN-20P	20"	Each	12/72

ALL PURPOSE CLEAN-UP BRUSHES



BRN-8P

BRN-20P

BRP-10

BRP-20

POT BRUSHES

- ◆ Wooden handle with coir bristles

ITEM	DESCRIPTION	UOM	CASE
BRP-10	10"	Each	12/72
BRP-20	20"	Each	6/48



= Cash & Carry / Retail Packaging

HEAVY-DUTY NATURAL LATEX GLOVES

- ◆ Soft, comfortable, and durable
- ◆ Made especially for dish washers, launderers, car washers, and gardeners

ITEM	DESCRIPTION	UOM	CASE
NLGH-18	10-1/2" x 18-1/2"	Pair	12/24

NATURAL LATEX GLOVES

ITEM	DESCRIPTION	COLOR	UOM	CASE
NLG-816	Small	Yellow	Pair	12/60
NLG-916	Medium	Yellow	Pair	12/60
NLG-1018	Large	Black	Pair	12/60

GLOVES

ITEM	DESCRIPTION	SIZE	UOM	CASE
GLFP-M	Vinyl Disposable, Powder-Free, 100 pcs/box	M	Box	10
GLFP-L	Vinyl Disposable, Powder-Free, 100 pcs/box	L	Box	10
GLP-M	PE Textured, 500 pcs/box	M	Box	10
GLP-L	PE Textured, 500 pcs/box	L	Box	10

WHITE SERVICE GLOVES

- ◆ 100% Cotton

ITEM	DESCRIPTION	COLOR	UOM	CASE
GLC-M	Medium (6 Pairs)	White	Doz	100
GLC-L	Large (6 Pairs)	White	Doz	100

GLOVES



NLGH-18



NLG-816



NLG-1018



GLP-M



GLC-M

WIPER BRACKET & GLOVE BOX HOLDER

ITEM	DESCRIPTION	DIMENSIONS	UOM	CASE
WHW-5	Wiper Bracket, Wall Mount	4" x 5" x 8-1/4"	Each	12/24
WHW-10	Glove Box Holder	10" x 3" x 5"	Each	12/24

WALL BRACKETS



WHW-5



WHW-10
(Gloves not included)

FIRST AID CABINET

- ◆ Stainless steel with lockable glass door

ITEM	DESCRIPTION	UOM	CASE
SFAC-12	12" x 12" x 4-3/4"	Each	4

FIRST AID CABINET



SFAC-12



= Cash & Carry / Retail Packaging

FLOOR MATS

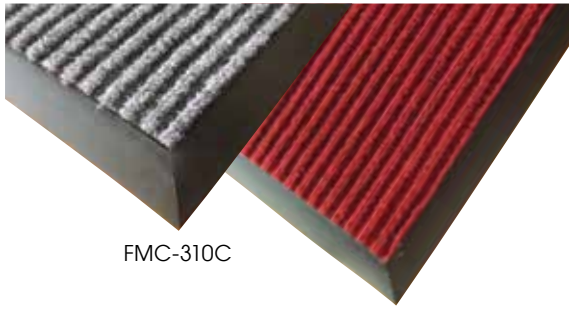

FMC-310C

FMC-310U



CARPET FLOOR MATS

- ◆ Vinyl backing prevents curling and ripping better than rubber and stays flat for safe footing

ITEM	DESCRIPTION	COLOR	UOM	CASE
FMC-310C	3' x 10'	Charcoal	Each	1
FMC-310U	3' x 10'	Burgundy	Each	1
FMC-35C	3' x 5'	Charcoal	Each	1
FMC-35U	3' x 5'	Burgundy	Each	1
FMC-46C	4' x 6'	Charcoal	Each	1
FMC-46U	4' x 6'	Burgundy	Each	1

WINCO FLOOR MATS	COMPETITOR FLOOR MATS

RUBBER FLOOR MATS

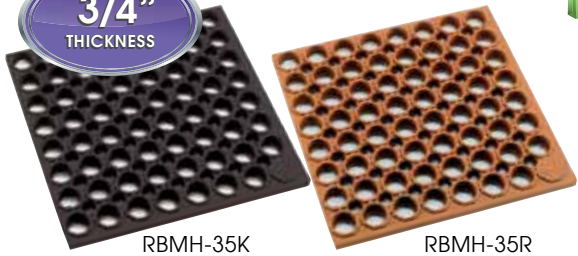

RBMH-35K

RBMH-35R

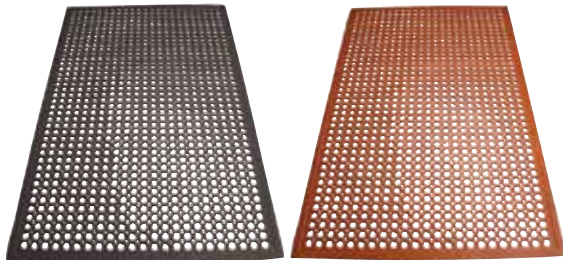

RBM-35K

RBM-35R

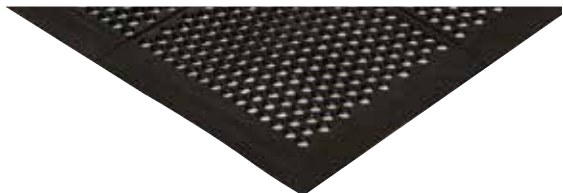

RBMM-35K

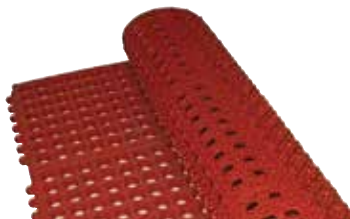

RBMI-33R

- ◆ Top-grade rubber
- ◆ Durable for long-term wear



STRAIGHT EDGE NATURAL RUBBER FLOOR MATS

- ◆ Grease resistant

ITEM	DESCRIPTION	COLOR	UOM	CASE
RBMH-35K*	3' x 5' x 3/4" Anti-Fatigue	Black	Each	1
RBMH-35R*	3' x 5' x 3/4" Grease-Proof	Red	Each	1

*Pallet rate pricing is available for this item with quantities of 50 pieces or more

BEVELED EDGE RUBBER FLOOR MATS

ITEM	DESCRIPTION	COLOR	UOM	CASE
RBM-35K*	3' x 5' x 1/2"	Black	Each	1
RBM-35R*	3' x 5' x 1/2"	Red	Each	1

*Pallet rate pricing is available for this item with quantities of 158 pieces or more

PREMIUM BEVELED EDGE RUBBER FLOOR MAT

- ◆ Natural rubber

ITEM	DESCRIPTION	COLOR	UOM	CASE
RBMM-35K	3' x 5' x 3/8"	Black	Each	1

RUBBER INTERLOCKING FLOOR MATS

ITEM	DESCRIPTION	COLOR	UOM	CASE
RBMI-33K	3' x 3' x 1/2"	Black	Each	1
RBMI-33R	3' x 3' x 1/2"	Red	Each	1

SLENDER TRASH CANS

◆ Lid sold separately

ITEM	DESCRIPTION	COLOR	UOM	CASE
PTC-23SG*	23 Gallon	Gray	Each	1
PTC-23B*	23 Gallon	Brown	Each	1
PTC-23K*	23 Gallon, Black	Black	Each	1
PTC-23L*	23 Gallon Recycle Can	Blue	Each	1
PTCL-23	Lid for PTC-23SG	Gray	Each	4
PTCL-23B	Lid for PTC-23B	Brown	Each	4
PTCL-23K	Lid for PTC-23K	Black	Each	4
PTCL-23L	Lid for PTC-23L	Blue	Each	4

*Pallet rate pricing is available for this item with quantities of 100 pieces or more

SPECIALTY LIDS

ITEM	DESCRIPTION	COLOR	UOM	CASE
PTCB-23L	Bottle/ Can Recycling Cover for PTC-23L	Blue	Each	6
PTCP-23L	Paper Recycling Cover for PTC-23L	Blue	Each	6

SLENDER TRASH CANS



HEAVY-DUTY TRASH CANS

◆ Lid sold separately

ITEM	DESCRIPTION	COLOR	UOM	CASE
PTC-32G*	32 Gallon	Gray	Each	1
PTC-44G**	44 Gallon	Gray	Each	1
FCW-10	10 Gallon, NSF	White	Each	6
FCW-20***	20 Gallon, NSF	White	Each	6
FCW-32***	32 Gallon, NSF	White	Each	6

*Pallet rate pricing is available for this item with quantities of 40 pieces or more **Pallet rate pricing is available for this item with quantities of 28 pieces or more ***Works with DLR-series dollies (see below section)

HEAVY-DUTY TRASH CAN LIDS

ITEM	DESCRIPTION	COLOR	UOM	CASE
PTCL-32	Lid for PTC-32G	Gray	Each	6
PTCL-44	Lid for PTC-44G	Gray	Each	6
FCW-10L	Lid for FCW-10, NSF	White	Each	24
FCW-20L	Lid for FCW-20, NSF	White	Each	12
FCW-32L	Lid for FCW-32, NSF	White	Each	12
FCW-10RC	Rotating Lid for FCW-10, NSF	White	Each	6
FCW-20RC	Rotating Lid for FCW-20, NSF	White	Each	6
FCW-32RC	Rotating Lid for FCW-32, NSF	White	Each	6

HEAVY-DUTY LARGE TRASH CANS



CAN ALSO BE USED FOR FOOD STORAGE

EXTRA HEAVY-DUTY DOLLY

◆ Holds up to 900 lbs

ITEM	DESCRIPTION	UOM	CASE
DLR-2	Extra-Heavy Dolly	Each	2
DLR-2-C	Caster for DLR-2	Each	1

DOLLIES



DOLLY

◆ Holds up to 400 lbs

ITEM	DESCRIPTION	UOM	CASE
DLR-18	18" Dia x 6" H, Black	Each	2
DLR-18-W	Caster for DLR-18	Each	1



= Cash & Carry / Retail Packaging

FLOOR CARE



MPB-36W

MPB-36



WCS-27T

WCS-25

CSF-4 & CSF-4H
(CSF-SET)

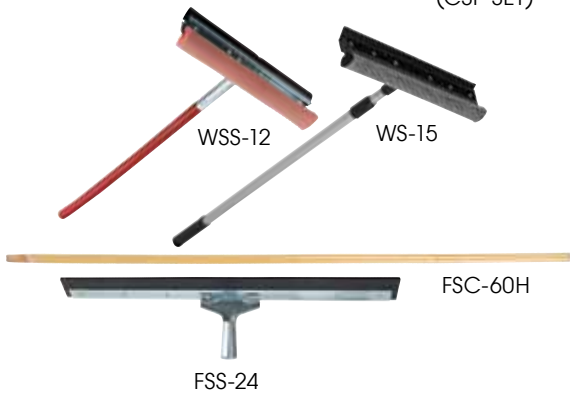

WSS-12

WS-15

FSC-60H

FSS-24



MOP-24C

MOP-32W



MOPH-7M

MOPH-7P

MOP BUCKET WITH SIDE PRESS WRINGER

ITEM	DESCRIPTION	UOM	CASE
MPB-36*	36 Qt, Yellow	Each	1
MPB-36W	Replacement Wringer for MPB-36	Each	2
MPB-36WH	Caster for MPB-36	Each	4

*Pallet rate pricing is available for this item with quantities of 30 pieces or more

FLOOR SIGNS

ITEM	DESCRIPTION	UOM	CASE
WCS-27T	27"H, Caution Cone	Each	5
WCS-25	25" x 12", English/Spanish Floor Sign	Each	12
CSF-4	Pop-up Caution Cone	Each	12/48
CSF-4H	Wall-Mount Holder for CSF-4	Each	48
CSF-SET	Set of CSF-4 and CSF-4H	Set	1

SQUEEGEES

ITEM	DESCRIPTION	UOM	CASE
WSS-12	12" with 23" Handle	Each	6/24
WS-15	15" Window Squeegee with Telescopic Handle Aluminum handle extends from 30" to 55"	Each	20
FSS-24	24", Straight Squeegee, Handle sold separately	Each	6
FSC-60H	56" Wooden Handle for FSS-24	Each	6

PREMIUM YARN MOP HEADS

- ◆ Poly cotton blend
- ◆ 4-ply yarn
- ◆ 1-1/4" narrow band

ITEM	DESCRIPTION	SIZE	UOM	CASE
MOP-24	Blue Loop End	24oz, 600g	Each	20
MOP-32	Blue Loop End	32oz, 800g	Each	20
MOP-24C	Blue Cut End	24oz, 600g	Each	20
MOP-32C	Blue Cut End	32oz, 800g	Each	20
MOP-24W	White Loop End	24oz, 600g	Each	20
MOP-32W	White Loop End	32oz, 800g	Each	20
MOP-24WC	White Cut End	24oz, 600g	Each	20
MOP-32WC	White Cut End	32oz, 800g	Each	20

MOP HANDLES

ITEM	DESCRIPTION	SIZE	UOM	CASE
MOPH-7M	Metal, Quick-Change	57"	Each	6
MOPH-7P	Plastic, Side-Release	57"	Each	6

FLOOR SCRUB BRUSH

ITEM	DESCRIPTION	UOM	CASE
BRF-10R	10" Wide	Each	12

HANDLES

ITEM	DESCRIPTION	UOM	CASE
BR-36W	36" Wooden Handle for BR-10	Each	48
BR-60W	55" Wooden Handle for BR-10	Each	6/24
FSC-60H	56" Wooden Handle for FSS-24	Each	6

CORN BROOMS

ITEM	DESCRIPTION	UOM	CASE
BRM-34	34" Wooden Handle, Toy Broom, 8.5" Width	Each	12
BRM-55	55" Metal Handle, 12" Width	Each	12/24

LOBBY BROOM AND PAN

- ◆ Built-in cover for mess-free transport

ITEM	DESCRIPTION	UOM	CASE
BRM-60L	60" Lobby Broom	Each	12
DP-13C	13" Lobby Pan	Set	10

DUST MOP

- ◆ 60" aluminum handle
- ◆ Handle, mop head, and frame all included

ITEM	DESCRIPTION	UOM	CASE
DM-24	24" Dust Mop	Each	12
DM-24H	Replacement Head for DM-24, Frame not Included	Each	24



MULTI-SURFACE SWEEPER

- ◆ Non-electric rotary sweeper with natural bristles and steel handle

ITEM	DESCRIPTION	UOM	CASE
FSW-11	11"L x 7-3/4"W x 43"H	Each	4



MOP & BROOM RACKS

Winco's mop, broom, and tool organizers are the perfect organizational tool to clean up kitchen clutter. Racks hold all types of kitchen tools and janitorial supplies. Maximize space by mounting organizers where items will be within easy reach.

- ◆ MHH-36 & MHH-24 constructed of aluminum with non-slip rubber fingers to hold tools securely in place
- ◆ MHH-5 constructed of durable ABS plastic with 6 hooks and 5 tool holders

ITEM	DESCRIPTION	UOM	CASE
MHH-5	16" Plastic Broom & Brush Organizer	Each	12
MHH-24	24" Mop Rack, Rubber Bristles	Each	6/24
MHH-36	36" Mop Rack, Rubber Bristles	Each	6/12

FLOOR CARE



= Cash & Carry / Retail Packaging

CUTTING BOARD BRUSHES

ITEM	DESCRIPTION	UOM	CASE
CBR-WT	White	Each	24/96
CBR-BN	Brown	Each	24/96
CBR-BU	Blue	Each	24/96
CBR-GR	Green	Each	24/96
CBR-RD	Red	Each	24/96
CBR-YL	Yellow	Each	24/96

BRUSHES



CBR-SERIES

BEER MUG WASHER

Eliminate hand scrubbing of glasses with Winco's Beer Mug Washer. The long-lasting nylon bristles are tough enough to get out grime, yet soft enough that they will not scratch or damage glasses. Four suction feet hold to surfaces, preventing movement while in use.

- ◆ Features one glass washer in the center with additional scrubbing bristles on the sides
- ◆ Wide enough to accommodate beer mugs, including handle
- ◆ Dirty water can be drained through detachable hose
- ◆ Durable plastic construction at space-saving size



GWB-1

ITEM	DESCRIPTION	UOM	CASE
GWB-1	Beer Mug Washer	Each	6

GLASS WASHER BRUSHES

- ◆ Four suction feet provides stability on slippery surfaces
- ◆ Dishwasher safe

ITEM	DESCRIPTION	UOM	CASE
GWB-3	3 Brushes with Base	Each	12
GWB-3-BR	Brush for GWB-3	Each	100



GWB-3

GWB-3-BR

COFFEE DECANTER BRUSH

ITEM	DESCRIPTION	UOM	CASE
CDB-11	11"L x 1-1/4"W x 1-1/4"H	Each	12/96



CDB-11

EQUIPMENT BRUSHES

ITEM	DESCRIPTION	SIZE	UOM	CASE
BR-24	L-Shaped Fryer Brush	24-1/2"	Each	12/96
BR-25	Urn Brush	25"	Each	12/96
BR-28	Kettle Valve Brush	28-1/4"	Each	12/96



BR-24

BR-25

BR-28

POT SCRUBBING BRUSHES

- ◆ Plastic handle with nylon bristles

ITEM	DESCRIPTION	UOM	CASE
BRN-8P	8"	Each	12/72
BRN-20P	20"	Each	12/72

ALL PURPOSE CLEAN-UP BRUSHES



BRN-8P

BRN-20P

BRP-10

BRP-20

POT BRUSHES

- ◆ Wooden handle with coir bristles

ITEM	DESCRIPTION	UOM	CASE
BRP-10	10"	Each	12/72
BRP-20	20"	Each	6/48



= Cash & Carry / Retail Packaging

OVEN & BROILER BRUSHES



BR-27



BR-30



BR-31



BR-21



BR-10



BR-36W

BR-60W



BR-9



BR-12

PIZZA OVEN SCRAPER

- ◆ Carbon wire brush and scraper

ITEM	DESCRIPTION	UOM	CASE
BR-27	Scraper with 27" Handle	Each	12

PIZZA OVEN BRUSH / BROILER BRUSH

- ◆ Stiff stainless steel wire bristles make cleaning heavy oven residue effortless
- ◆ Quick and easy removal of heavy carbon deposits, rust, and burned-on food buildup

ITEM	DESCRIPTION	UOM	CASE
BR-30	Brush with 30" Handle	Each	8/32

COMMERCIAL BROILER BRUSH

- ◆ Bristle: steel wire (1-1/4"); Weight: 1.63 lbs
- ◆ Brush base: beach wooden handle (7-11/16"L x 2-19/32"W x 1-1/64"H)
- ◆ Handle: zinc plated iron (exterior diameter: 3/4", interior diameter: 5/8")

ITEM	DESCRIPTION	UOM	CASE
BR-31	Broiler Brush	Each	12

DUAL-HEADED BRUSH

- ◆ Thick brush has steel wire bristles trimmed to 40mm
- ◆ Thin brush has flat steel wire bristles trimmed to 30mm
- ◆ Replacement kit includes dual-headed brush, bolt, and nut



ITEM	DESCRIPTION	UOM	CASE
BR-21	Dual-Headed Brush with 28" S/S Handle	Each	6
BR-21-HM	Brush Replacement Kit for BR-21	Box	18

PIZZA OVEN BRUSH HEAD

- ◆ Brass bristles with scraper

ITEM	DESCRIPTION	UOM	CASE
BR-10	Brush Head, 10-1/4" x 1-3/8" x 1-3/4"	Each	12/48
BR-36W	36" Wooden Handle for BR-10	Each	48
BR-60W	55" Wooden Handle For BR-10	Each	6/24

BUTCHER BLOCK BRUSH

ITEM	DESCRIPTION	UOM	CASE
BR-9	Steel Bristles	Each	6/12

OVEN & GRILL / BBQ BRUSH

ITEM	DESCRIPTION	UOM	CASE
BR-12	12" Long, Brass Bristles	Each	12/72

BATHROOM NECESSITIES

TWIN ROLLS TOILET TISSUE DISPENSER

- ◆ Dispenser will accommodate two tissue paper rolls, each with an approximate size of 9-1/2" Dia x 4"H and each with an approximate weight of 1.71 lbs.

ITEM	DESCRIPTION	UOM	CASE
TD-220	Twin Rolls	Each	3



TD-220

JUMBO ROLL PAPER DISPENSERS

- ◆ Dispenser will accommodate a tissue paper roll size of 12-1/2" Dia x 4"H with an approximate weight of 4.18 lbs.

ITEM	DESCRIPTION	UOM	CASE
TD-120	14" Dia	Each	3
TD-120S	11" Dia	Each	6



TD-120S



TTH-1



TTH-2



TOILET TISSUE HOLDERS

- ◆ Chrome plated steel

ITEM	DESCRIPTION	UOM	CASE
TTH-1	Single Roll	Each	36
TTH-2	Double Roll	Each	24

TOILET SEAT COVERS

ITEM	DESCRIPTION	UOM	CASE
TSC-10	Half-Fold Dispenser	Each	20
TSC-250	Half-Fold Covers, 250 pcs/bag	Bag	20



TSC-10



TSC-250

RUBBER PLUNGER

ITEM	DESCRIPTION	UOM	CASE
TP-300	19", Wooden Handle	Each	48



TP-300



BR-15

TOILET BRUSH

ITEM	DESCRIPTION	UOM	CASE
BR-15	12", Plastic Handle	Each	12/48

URINAL SCREEN WITH DEODORIZER BLOCK

ITEM	DESCRIPTION	UOM	CASE
USF-4	Screen & Deodorizer	Each	12/144

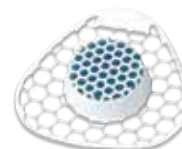

USF-4



= Cash & Carry / Retail Packaging

HOOD FILTERS

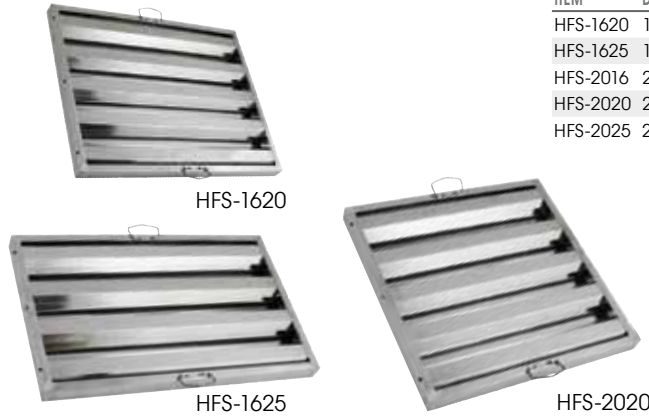

STAINLESS STEEL HOOD FILTERS

ITEM	DESCRIPTION	UOM	CASE
HFS-1620	16"W x 20"H	Each	6
HFS-1625	16"W x 25"H	Each	6
HFS-2016	20"W x 16"H	Each	6
HFS-2020	20"W x 20"H	Each	6
HFS-2025	20"W x 25"H	Each	6

INSECT CONTROL



INSECT ZAPPER

- ◆ UVA bulbs attract insects to cylinder; high voltage kills them
- ◆ Made for indoor or outdoor use
- ◆ 1,600 ft² range

ITEM	DESCRIPTION	UOM	CASE
EIZ-1E	Electric Insect Zapper	Each	1



INSECT TRAPPER

- ◆ Two shatter-proof 15W UV lamps attract insects to glue board
- ◆ Eco-friendly; no toxic chemical emissions
- ◆ Conforms to international hygiene standards
- ◆ 1,100 ft² range

ITEM	DESCRIPTION	UOM	CASE
EIZ-2G	Insect Glue Trap	Each	4
EIZ-2G-GB	Glue Board for EIZ-2G, No Retail Pkg.	Each	50/250

JANITORIAL ACCESSORIES



PAIL OPENER

- ◆ Aluminum

ITEM	DESCRIPTION	UOM	CASE
POA-8	8-7/16" x 1-7/16" x 2-3/4"	Each	6/72



SINK STRAINER

- ◆ Stainless steel

ITEM	DESCRIPTION	UOM	CASE
SIK-3	3"Dia w/Stopper	Each	24/144

OVERFLOW PIPES

ITEM	DESCRIPTION	UOM	CASE
OP-7	7" x 1" Dia	Each	24/288
OP-11	11" x 1" Dia	Each	12/144

RUBBER SCRAP BLOCK

ITEM	DESCRIPTION	UOM	CASE
RSB-6	6-1/2" Dia x 4" Deep	Each	12

PLASTIC FUNNELS

ITEM	DESCRIPTION	SIZE	UOM	CASE
PF-8	8 Oz	4" Dia	Each	6/324
PF-16	16 Oz	5-1/4" Dia	Each	6/324
PF-32	32 Oz	6-1/4" Dia	Each	6/216

WIDE MOUTH FUNNELS & REMOVABLE STRAINERS

- ◆ Stainless steel mirror finish for SF-5 and SF-6

ITEM	DESCRIPTION	UOM	CASE
SF-5	5" Funnel	Each	12/72
SF-6	5-3/4" Funnel	Each	12/72
SF-6S	Strainer for SF-6	Each	120/480

OVEN & BROILER BRUSHES



BR-27



BR-30



BR-31



BR-21



BR-10



BR-36W

BR-60W



BR-9



BR-12

PIZZA OVEN SCRAPER

- ◆ Carbon wire brush and scraper

ITEM	DESCRIPTION	UOM	CASE
BR-27	Scraper with 27" Handle	Each	12

PIZZA OVEN BRUSH / BROILER BRUSH

- ◆ Stiff stainless steel wire bristles make cleaning heavy oven residue effortless
- ◆ Quick and easy removal of heavy carbon deposits, rust, and burned-on food buildup

ITEM	DESCRIPTION	UOM	CASE
BR-30	Brush with 30" Handle	Each	8/32

COMMERCIAL BROILER BRUSH

- ◆ Bristle: steel wire (1-1/4"); Weight: 1.63 lbs
- ◆ Brush base: beach wooden handle (7-11/16"L x 2-19/32"W x 1-1/64"H)
- ◆ Handle: zinc plated iron (exterior diameter: 3/4", interior diameter: 5/8")

ITEM	DESCRIPTION	UOM	CASE
BR-31	Broiler Brush	Each	12

DUAL-HEADED BRUSH

- ◆ Thick brush has steel wire bristles trimmed to 40mm
- ◆ Thin brush has flat steel wire bristles trimmed to 30mm
- ◆ Replacement kit includes dual-headed brush, bolt, and nut



ITEM	DESCRIPTION	UOM	CASE
BR-21	Dual-Headed Brush with 28" S/S Handle	Each	6
BR-21-HM	Brush Replacement Kit for BR-21	Box	18

PIZZA OVEN BRUSH HEAD

- ◆ Brass bristles with scraper

ITEM	DESCRIPTION	UOM	CASE
BR-10	Brush Head, 10-1/4" x 1-3/8" x 1-3/4"	Each	12/48
BR-36W	36" Wooden Handle for BR-10	Each	48
BR-60W	55" Wooden Handle For BR-10	Each	6/24

BUTCHER BLOCK BRUSH

ITEM	DESCRIPTION	UOM	CASE
BR-9	Steel Bristles	Each	6/12

OVEN & GRILL / BBQ BRUSH

ITEM	DESCRIPTION	UOM	CASE
BR-12	12" Long, Brass Bristles	Each	12/72

ALUMINUM GRILL SCRAPER

A great way to clean the grill quickly and safely. The handle is designed to keep hands and fingers away from the hot grill surface.

ITEM	DESCRIPTION	BLADE	UOM	CASE
SCRP-16	16" Scraper	5"	Each	6
SCRP-5B	Replacement Blade for SCR-16		Each	12/48

GRILL MAINTENANCE



ECONOMY GRILL SCRAPER

ITEM	DESCRIPTION	BLADE	UOM	CASE
SCRP-12	12" Scraper, Alu	4"	Each	12/72
SCRP-4B	Replacement Blades for SCR-12, 10 pcs/pk		Pack	10/100



GRIDDLE CLEANERS

ITEM	DESCRIPTION	UOM	CASE
GSH-1	Griddle Screen Holder, 5" x 2-3/4"	Each	6/48
GSN-4	Grill Screen, Fits with GSH-1; 4" x 5-1/2", 20 pcs/pk;	Pack	20/80
GBH-2	Griddle Brick Holder, 7" x 3-1/2"	Each	6/72
GBK-348	Grill Brick, Fits with GBH-2; 3-1/2" x 4" x 8";	Doz	1

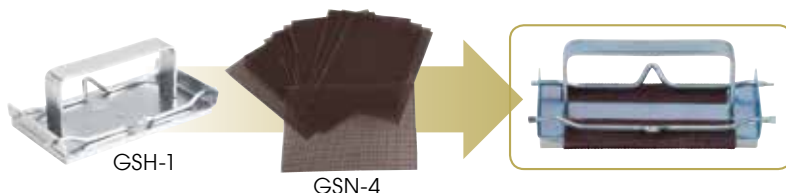

MINI UTILITY BRUSHES

◆ Ideal for cleaning ceramic tiles and narrow spaces

ITEM	DESCRIPTION	UOM	CASE
BR-7B	7" Brush, Brass Bristles	Each	48/576
BR-7S	7" Brush, S/S Wire Bristles	Each	48/576

SCRATCH BRUSHES



SCRATCH BRUSHES

ITEM	DESCRIPTION	UOM	CASE
BR-319	14" Long, Steel Bristles	Each	12
BR-500	20" Long, Wire Bristles	Each	6/48

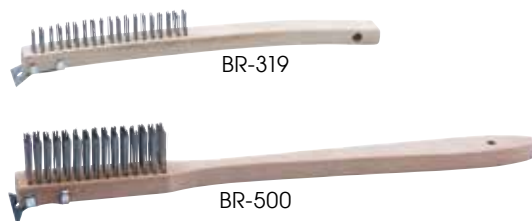

= Cash & Carry / Retail Packaging

BATHROOM NECESSITIES



TD-600



TD-700



TD-300



TD-330



TD-500



AFD-1



SD-100



PAPER TOWEL CABINETS

- ◆ Dispenses 400 C-Fold or 525 multi-fold towels (3-1/8" to 3-13/16") without adjustments or adapters

ITEM	DESCRIPTION	UOM	CASE
TD-600	White Epoxy Coated Iron	Each	6
TD-700	Stainless Steel	Each	6

M-FOLD PAPER TOWEL DISPENSER

- ◆ Dispenser will accommodate paper pack size of 8-1/2" x 3-1/8" x 6"; maximum 200 pieces with an approximate weight of 0.88 lbs

ITEM	DESCRIPTION	UOM	CASE
TD-300	M-Fold /C-Fold	Each	10

PAPER TOWEL DISPENSER

- ◆ Dispenser will accommodate a paper roll size of 7-7/8" Dia x 7-7/8"H with an approximate weight of 3.19 lbs

ITEM	DESCRIPTION	UOM	CASE
TD-330	Center-Pull	Each	6

PAPER TOWEL DISPENSER, LEVER HANDLE

- ◆ Dispenser will accommodate a paper roll size of 7-1/2" Dia x 7-7/8"H with an approximate weight of 3.30 lbs

ITEM	DESCRIPTION	UOM	CASE
TD-500	Roll Paper Towel Dispenser	Each	3



AUTOMATIC AIR FRESHENER

- ◆ Fully programmable dispenser
- ◆ Spraying interval of 5, 10, 15, or 30 minutes
- ◆ Working time setting options of day, night, or 24 hours
- ◆ Accommodates standard size 6.6oz refill sprays, not included

ITEM	DESCRIPTION	UOM	CASE
AFD-1	Automatic Air Freshener	Each	6/24

MANUAL SOAP DISPENSER

ITEM	DESCRIPTION	UOM	CASE
SD-100	Soap Dispenser, 1L	Each	24

BATHROOM NECESSITIES

TWIN ROLLS TOILET TISSUE DISPENSER

◆ Dispenser will accommodate two tissue paper rolls, each with an approximate size of 9-1/2" Dia x 4"H and each with an approximate weight of 1.71 lbs.

ITEM	DESCRIPTION	UOM	CASE
TD-220	Twin Rolls	Each	3



TD-220

JUMBO ROLL PAPER DISPENSERS

◆ Dispenser will accommodate a tissue paper roll size of 12-1/2" Dia x 4"H with an approximate weight of 4.18 lbs.

ITEM	DESCRIPTION	UOM	CASE
TD-120	14" Dia	Each	3
TD-120S	11" Dia	Each	6



TD-120S



TTH-1



TTH-2



TOILET TISSUE HOLDERS

◆ Chrome plated steel

ITEM	DESCRIPTION	UOM	CASE
TTH-1	Single Roll	Each	36
TTH-2	Double Roll	Each	24

TOILET SEAT COVERS

ITEM	DESCRIPTION	UOM	CASE
TSC-10	Half-Fold Dispenser	Each	20
TSC-250	Half-Fold Covers, 250 pcs/bag	Bag	20



TSC-10



TSC-250

RUBBER PLUNGER

ITEM	DESCRIPTION	UOM	CASE
TP-300	19", Wooden Handle	Each	48



TP-300



BR-15

TOILET BRUSH

ITEM	DESCRIPTION	UOM	CASE
BR-15	12", Plastic Handle	Each	12/48

URINAL SCREEN WITH DEODORIZER BLOCK

ITEM	DESCRIPTION	UOM	CASE
USF-4	Screen & Deodorizer	Each	12/144

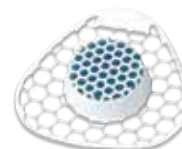

USF-4



= Cash & Carry / Retail Packaging

HOOD FILTERS

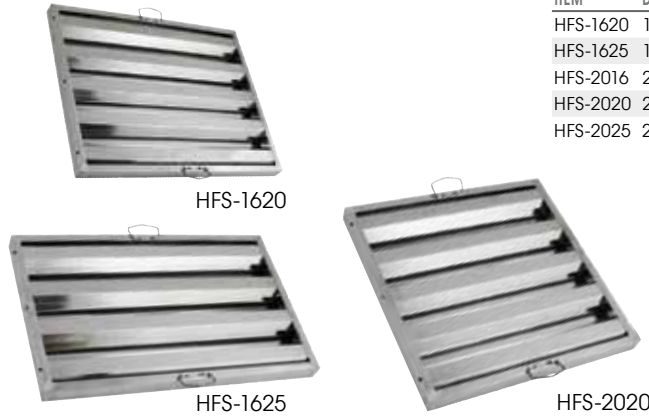

STAINLESS STEEL HOOD FILTERS

ITEM	DESCRIPTION	UOM	CASE
HFS-1620	16"W x 20"H	Each	6
HFS-1625	16"W x 25"H	Each	6
HFS-2016	20"W x 16"H	Each	6
HFS-2020	20"W x 20"H	Each	6
HFS-2025	20"W x 25"H	Each	6

INSECT CONTROL



INSECT ZAPPER

- ◆ UVA bulbs attract insects to cylinder; high voltage kills them
- ◆ Made for indoor or outdoor use
- ◆ 1,600 ft² range

ITEM	DESCRIPTION	UOM	CASE
EIZ-1E	Electric Insect Zapper	Each	1



INSECT TRAPPER

- ◆ Two shatter-proof 15W UV lamps attract insects to glue board
- ◆ Eco-friendly; no toxic chemical emissions
- ◆ Conforms to international hygiene standards
- ◆ 1,100 ft² range

ITEM	DESCRIPTION	UOM	CASE
EIZ-2G	Insect Glue Trap	Each	4
EIZ-2G-GB	Glue Board for EIZ-2G, No Retail Pkg.	Each	50/250

JANITORIAL ACCESSORIES



PAIL OPENER

- ◆ Aluminum

ITEM	DESCRIPTION	UOM	CASE
POA-8	8-7/16" x 1-7/16" x 2-3/4"	Each	6/72



SINK STRAINER

- ◆ Stainless steel

ITEM	DESCRIPTION	UOM	CASE
SIK-3	3"Dia w/Stopper	Each	24/144

OVERFLOW PIPES

ITEM	DESCRIPTION	UOM	CASE
OP-7	7" x 1" Dia	Each	24/288
OP-11	11" x 1" Dia	Each	12/144

RUBBER SCRAP BLOCK

ITEM	DESCRIPTION	UOM	CASE
RSB-6	6-1/2" Dia x 4" Deep	Each	12

PLASTIC FUNNELS

ITEM	DESCRIPTION	SIZE	UOM	CASE
PF-8	8 Oz	4" Dia	Each	6/324
PF-16	16 Oz	5-1/4" Dia	Each	6/324
PF-32	32 Oz	6-1/4" Dia	Each	6/216

WIDE MOUTH FUNNELS & REMOVABLE STRAINERS

- ◆ Stainless steel mirror finish for SF-5 and SF-6

ITEM	DESCRIPTION	UOM	CASE
SF-5	5" Funnel	Each	12/72
SF-6	5-3/4" Funnel	Each	12/72
SF-6S	Strainer for SF-6	Each	120/480